

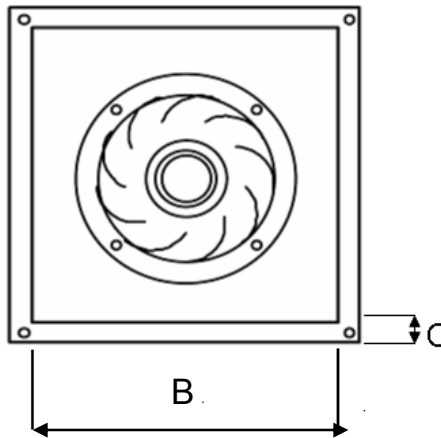

## DKHR560-4D Backward Curve In-Line Fan

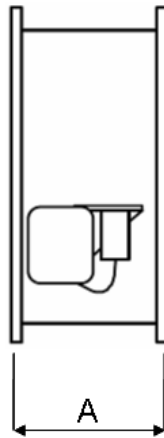

A	B	C	Amps	Controller
500	700	30	4.1	RTD5.0

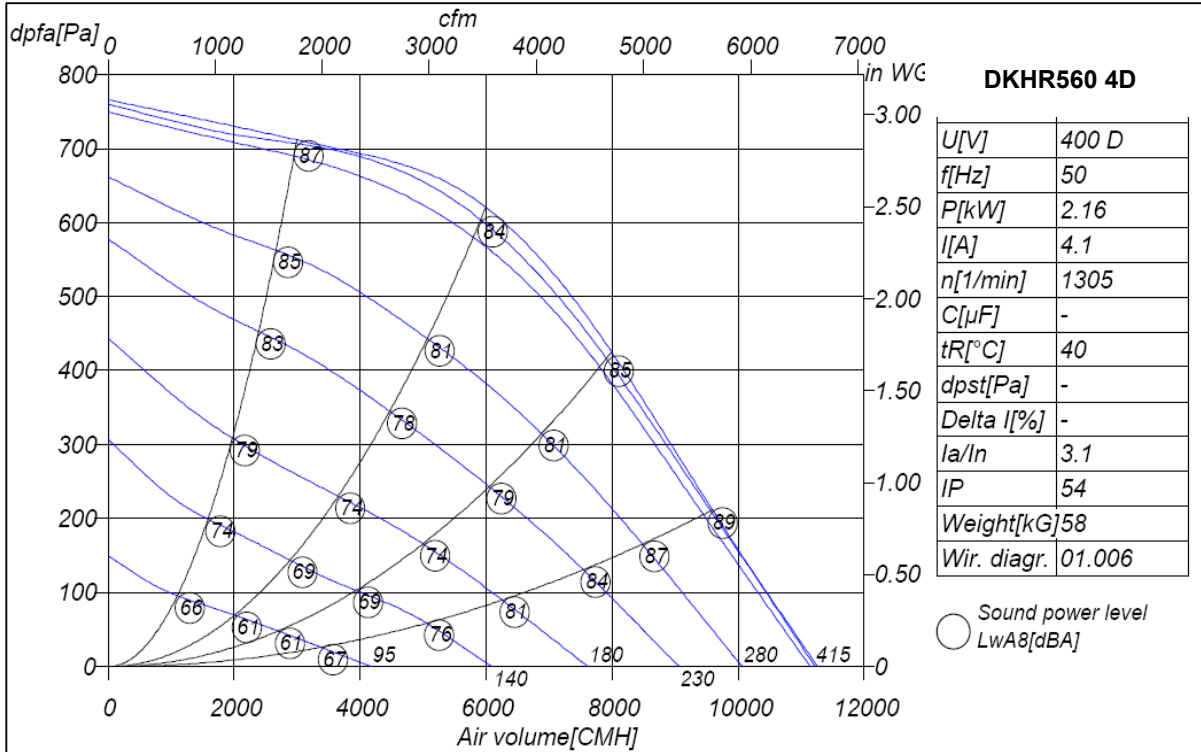
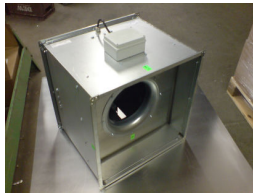

## DKHR560-4D Backward Curve In-Line Fan

### DKHR560-4D

Drehstrommotor in  $\Delta$ -Schaltung mit Thermostatschalter (TB).  
Drehrichtungsänderung durch Vertauschen von 2 Phasen.

**Three phase motor in delta connection with thermostatic switch (TB). Changing of rotation direction by interchanging of 2 phases.**

***Moteur triphasé branché en triangle avec interrupteur thermostatique (TB). Changement de sens de rotation par inversion de deux phases.***

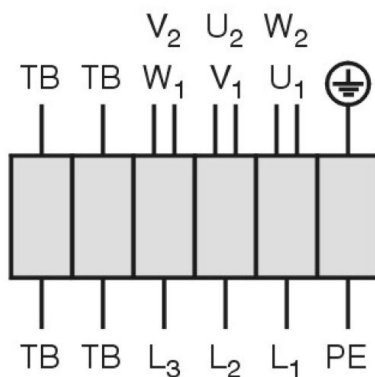

U <sub>1</sub>	braun / brown / brun
V <sub>1</sub>	blau / blue / bleu
W <sub>1</sub>	schwarz / black / noir
U <sub>2</sub>	rot / red / rouge
V <sub>2</sub>	grau / grey / gris
W <sub>2</sub>	orange / orange / orange
TB	weiß / white / blanc
PE	gelb-grün yellow-green jaune-vert

01.006

TK3-20004