



Incorporating



Grilles & Diffusers

Series NV Non-vision grilles

- Sight blocking design ensures privacy is maintained
- Perfect for areas like changing rooms
- Four models available including units to suit door mounting and dark room installations



Series NV

Series NV non-vision grilles are intended to provide good levels of ventilation for areas where privacy must be ensured; bathrooms or hospital examination rooms for example.

Available in the following models:

NV1: Standard flanged grille.

NV2: As NV1 but with a spare backing frame for fitting into doors.

NV3: Double layered grille intended for dark-rooms.

NV4: Slimline surface mounted with a non chevron blade. Designed to suit fire doors.

Please note: A very narrow sight line can be gained through NV4 grilles if looked at from directly below.

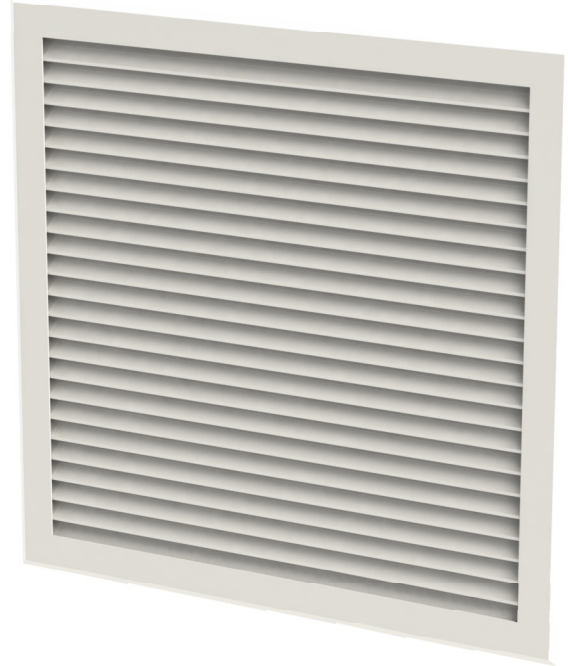

Design features

Material	Extruded aluminium frame and core
Frame	NV1 - NV3: 37BN - 37mm bevelled NV4: SMS - Surface mounted small
Sizes	Minimum: 100mm x 100mm Maximum: 2900mm x 2900mm
Fixings	Standard: None Optional: See page 4
Finish	Standard: Satin anodised (AA5) Optional: See page 6
Mass/m² face area	NV1: 12.5kg NV2: 15 kg NV3: 23 kg NV4: 11 kg
Free area	NV1 - NV3: Approx 38% NV4: Approx 30%

Quality assurance

HVC Supplies (Stourbridge) Ltd is an ISO 9001 certified company.



Assessed to ISO 9001
Cert/Ref No. 1186

Models

NV1: Standard flanged grille

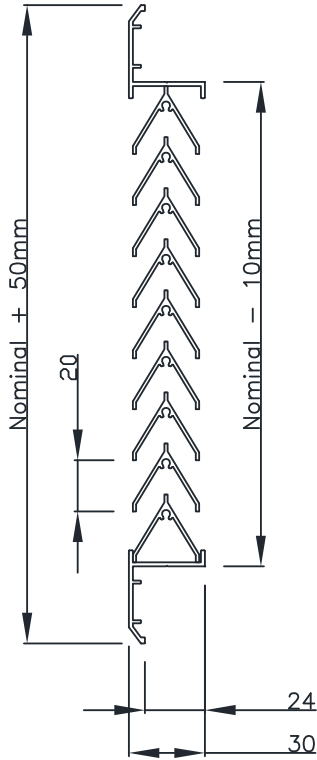

NV2: Door grille

As NV1 but with a spare frame for mounting on the other side of a door.

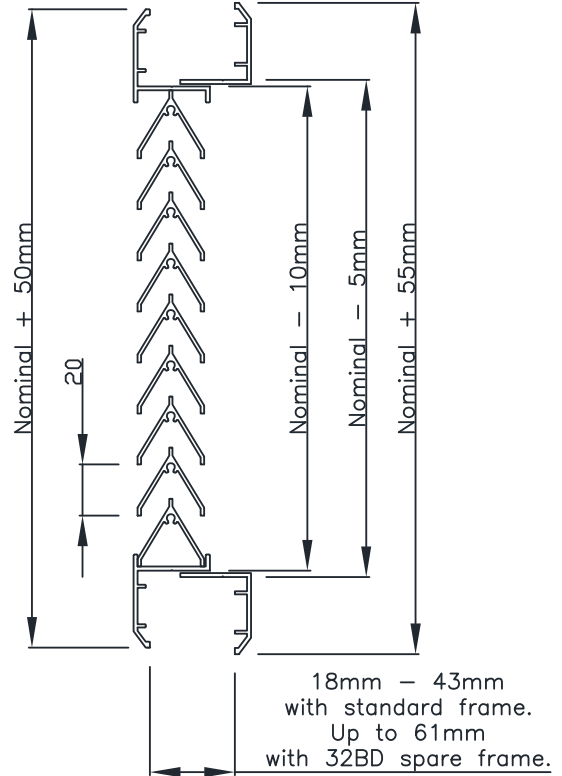

NV3: Double layered grille for darkrooms

Two grilles supplied separately with trimmed frames for mounting either side of an aperture.

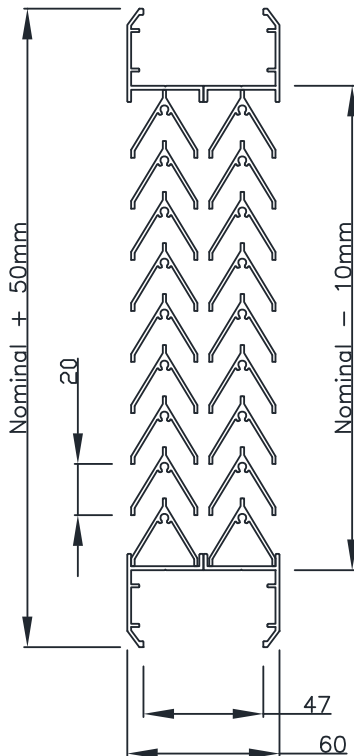

NV4: Surface mounted

Designed for use in fire doors to conceal an intumescent fire damper, HVC Series IFBM (supplied separately).

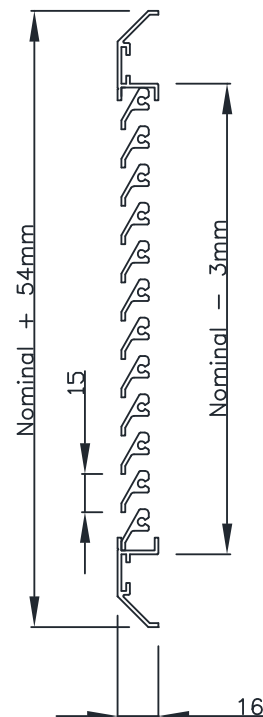

Stocked sizes

The following sizes of Series NV4 surface mounted non-vision grilles are held in stock in satin anodised finish and with prepunched fixing holes, available for immediate despatch.

150mm²
200mm²
250mm²
300mm²
350mm²
400mm²
450mm²
500mm²
550mm²
600mm²

All sizes are nominal.

Product code: NV4 - FH - SAA

Fixings

Countersunk fixing holes: Code suffix FH

For simple fitting, countersunk fixing holes can be punched into the outer frame.

Self tapping screws in the same finish as the grille are provided as standard.

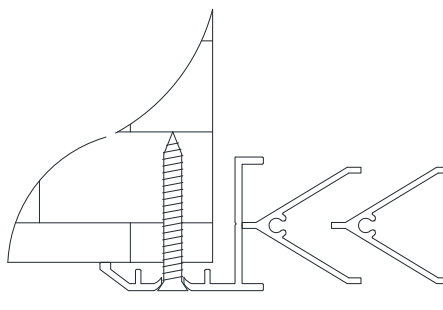

Selection data (NV1 and NV2 only)

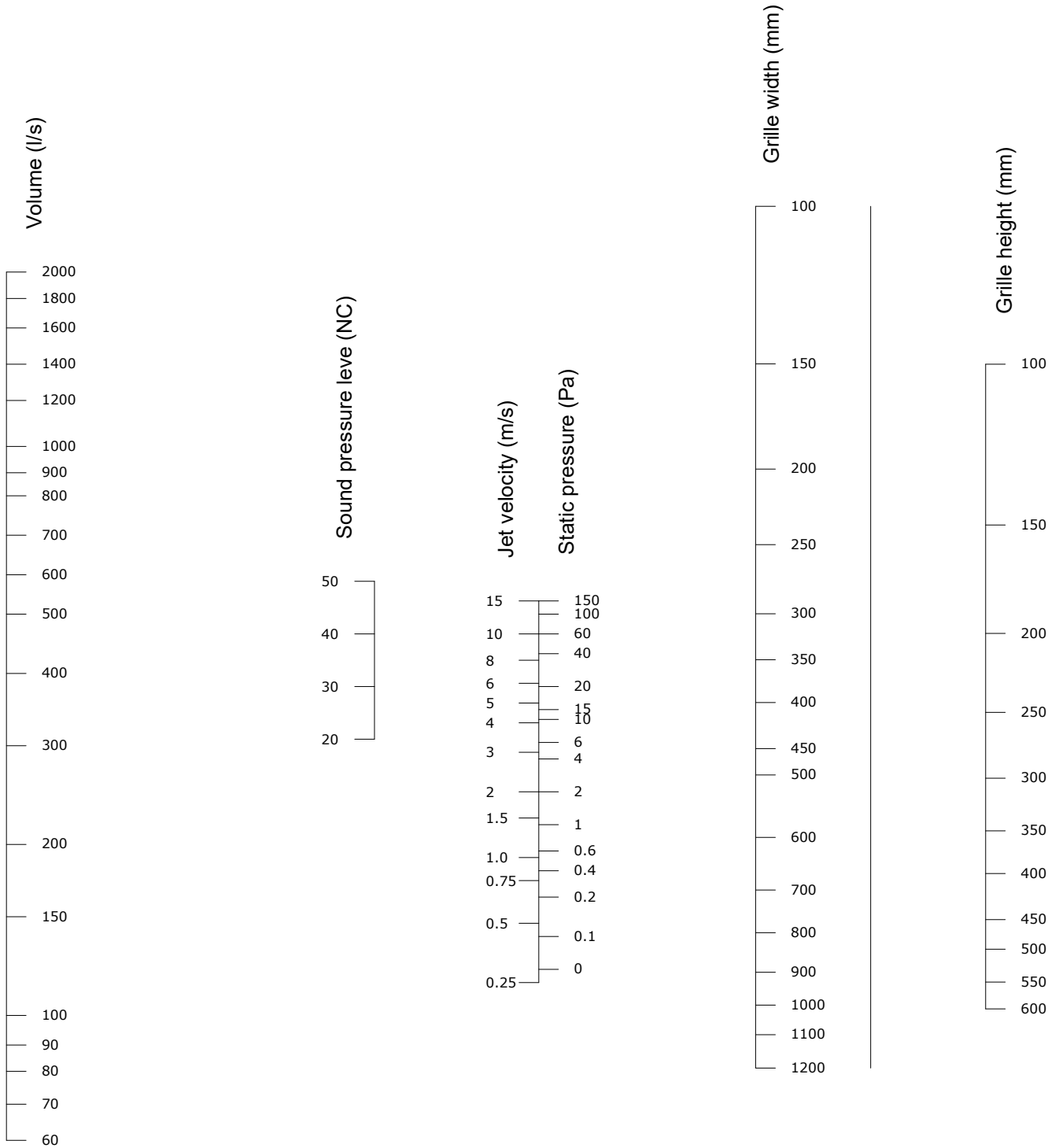

Finishes

Satin anodised aluminium

Polyester powder coating to any RAL or BS colour



Ordering codes

Example

1 - 400 x 400 - NV1 - FH - RAL9010

Codes

1)	Quantity		
2)	Size (mm)	(Width x height)	
3)	Series	NV1 NV2 NV3 NV4	Standard flanged non-vision grille As NV1 but with spare backing frame for use with doors Please state if deeper frame is required for doors up to 78mm thick Double layered grille for dark-rooms Slimline surface mounted non-vision grille
4)	Fixings	FH	Countersunk fixing holes (optional with NV1, 2 and 3, standard with NV4)
5)	Finish	SAA RAL... BS...	Satin anodised frame (standard) Polyester powder coated to RAL... Polyester powder coated to BS...

Important: Size will be taken to be nominal (hole internal) unless stated otherwise.

Leave code section blank if no option is required.

HVC & NCA products

HVC offer the significant advantage of manufacturing both in duct and duct terminal equipment, making us a one stop shop for all your HVAC needs.

The products shown below are a selection, not an exhaustive list. Go to www.h-v-c.com for details on all HVC and NCA products.

HVC: Grilles, Diffusers, Louvres and Volume Control Dampers

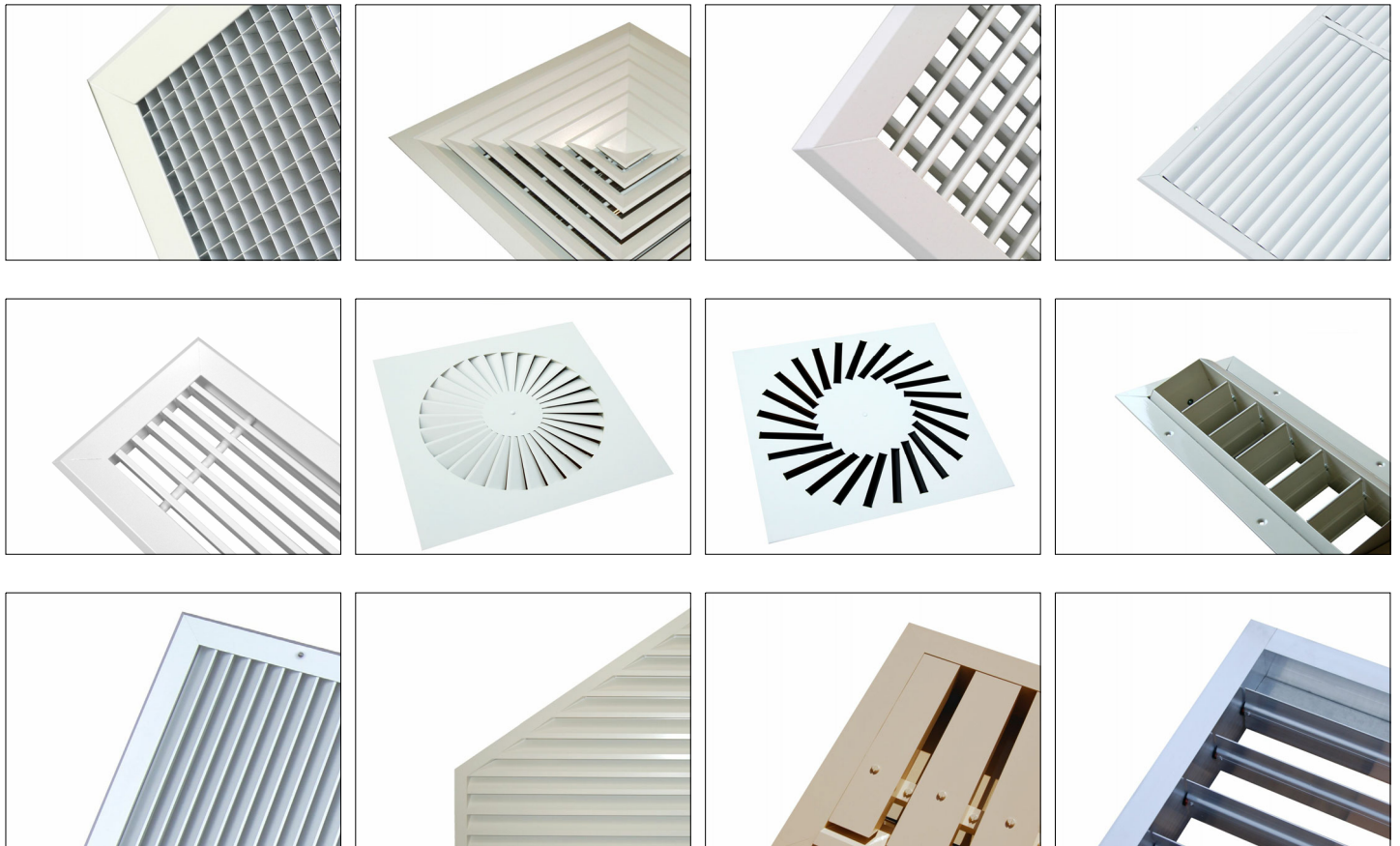

NCA: Fire and Volume Control Dampers





Assessed to ISO 9001
Cert/Ref No. 1186

HVC Supplies (Stourbridge) Ltd
Jason House
Amblecote
West Midlands
DY8 4EY
United Kingdom

Tel: +44 (0)1384 376555
Fax: +44 (0)1384 392555

sales@h-v-c.com

www.h-v-c.com

All details within this brochure are correct at time of publication. However HVC's policy is one of continual product development. The right is reserved to alter any details published in this brochure without any prior notice. Any changes will appear on www.h-v-c.com as soon as is practically possible.

All information in this brochure is designed to be used for informative purposes only. HVC will not be legally bound by anything contained within this publication, or any other information distributed.

All references to companies not part of the HVC group of companies are used with the permission of their respective owners.